



REACH – special subject: communication between companies

What are communication lines within REACH and linked regulation?

Erik Geensen
Quick-SDS
May 14th 2009



Communication in and between companies in REACH

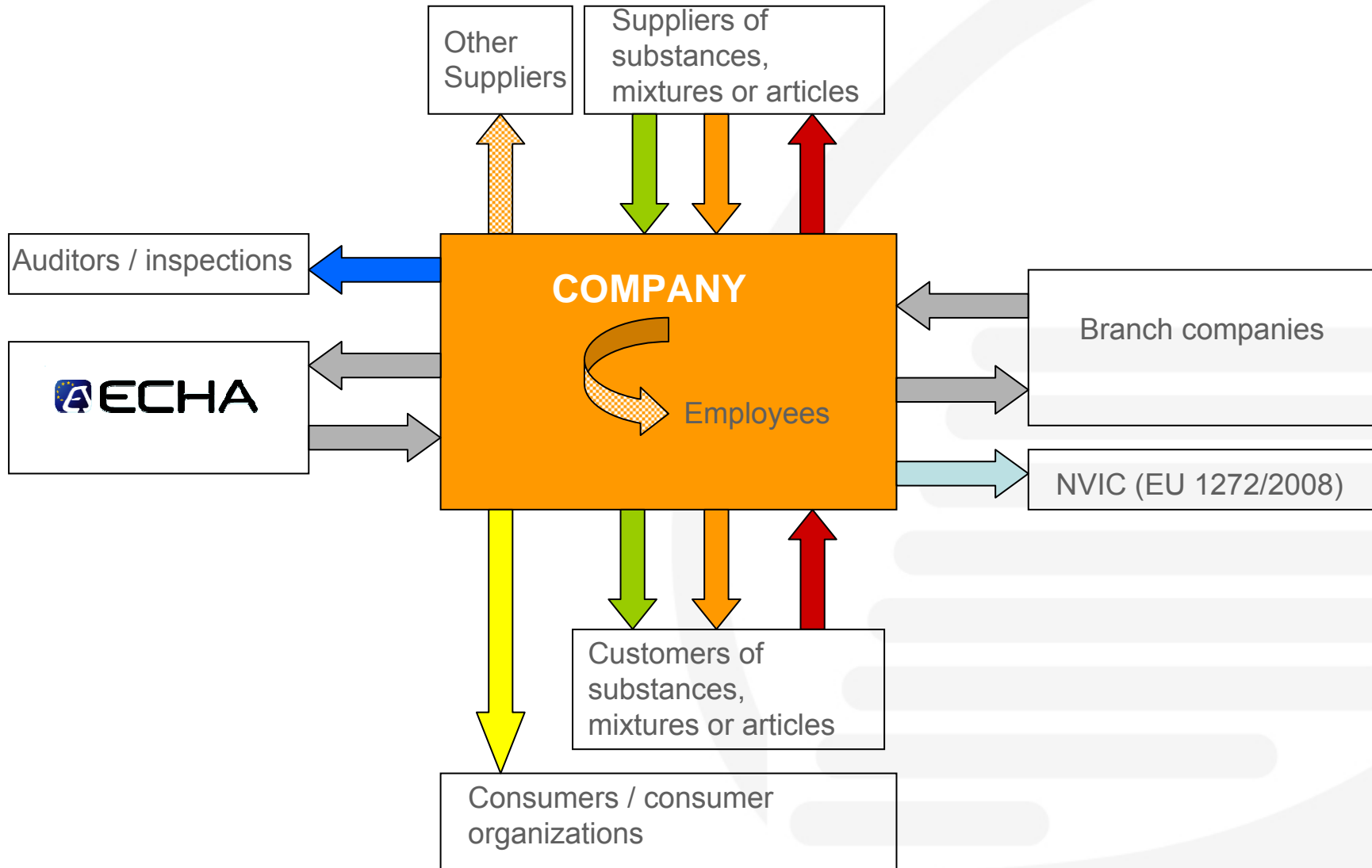



Communication of SDS in the supply chain

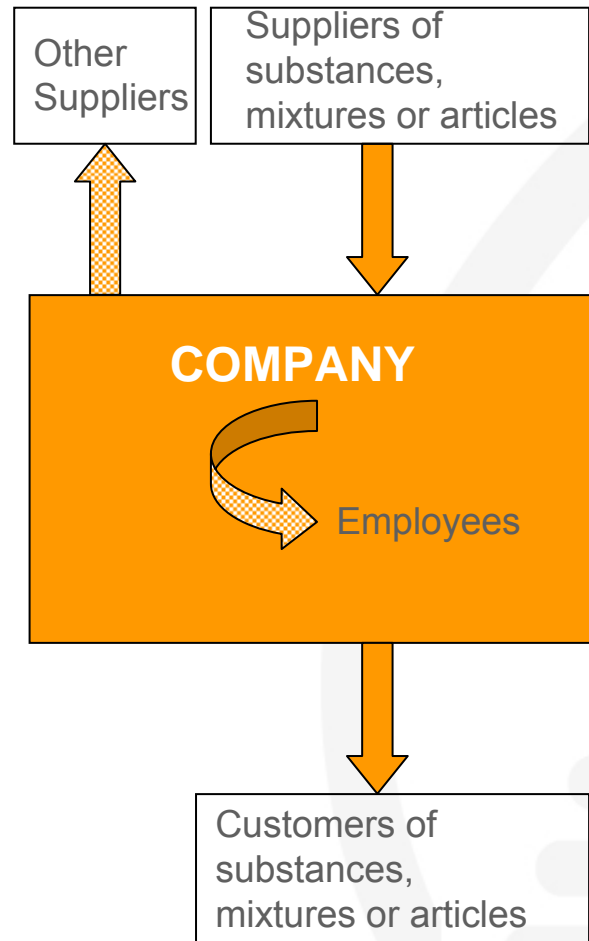



Main consistencies and relationships in SDS

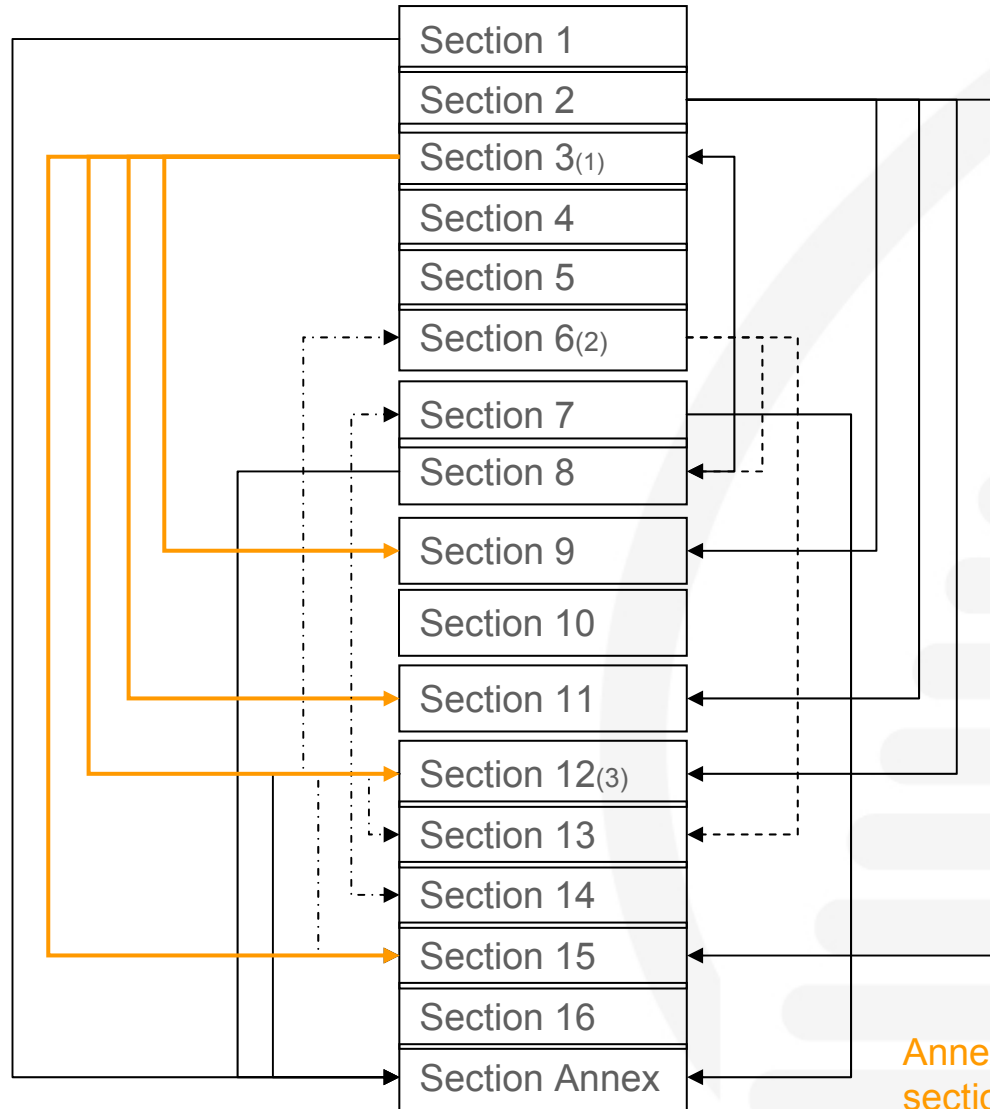

(1) Section 3, 9, 11, 12 and 15 are included in the SDS Checker Diagnosis Report of Quick-SDS
→

(2) Section 6 should be linked to sections 8 and 13 in case of necessity
----->

(3) Sections 6, 7, 12, 13, 14, and 15 of the SDS should provide information to prevent environmental consequences
----->

Annex is linked to sections 1, 7, 8 and 12



REACH: regulatory SDS distribution

<i>Regulation EG 1907/2006</i>	<i>Description</i>	<i>Solution in Quick-SDS</i>
Article 31 – 1	Providing SDS of dangerous substances to customer (proactive)	Sending SDS to customers on initiative of your company
Article 31 – 8	SDS can be provided electronically or on paper	Quick-SDS can provide SDS in different formats
Article 31 – 9	Updates of SDS must be provided to customers which ordered the substance in the last 12 months	‘Subscription’ of a customer to SDS during a period of e.g. 12 months via email alert
Article 35	SDS of substance is available for employees which are exposed to the substance	Access to Quick-SDS database for employees of your company
Article 36 – 1	Obligation to save information at least until 10 years after last delivery of the substance	Quick-SDS saves all information on SDS access: ‘to whom is what provided and when?’

REACH is not completely new: SDS distribution is applicable from 1967!!

Quick-SDS was developed long before REACH.



For users of chemical substances: SDS Retriever

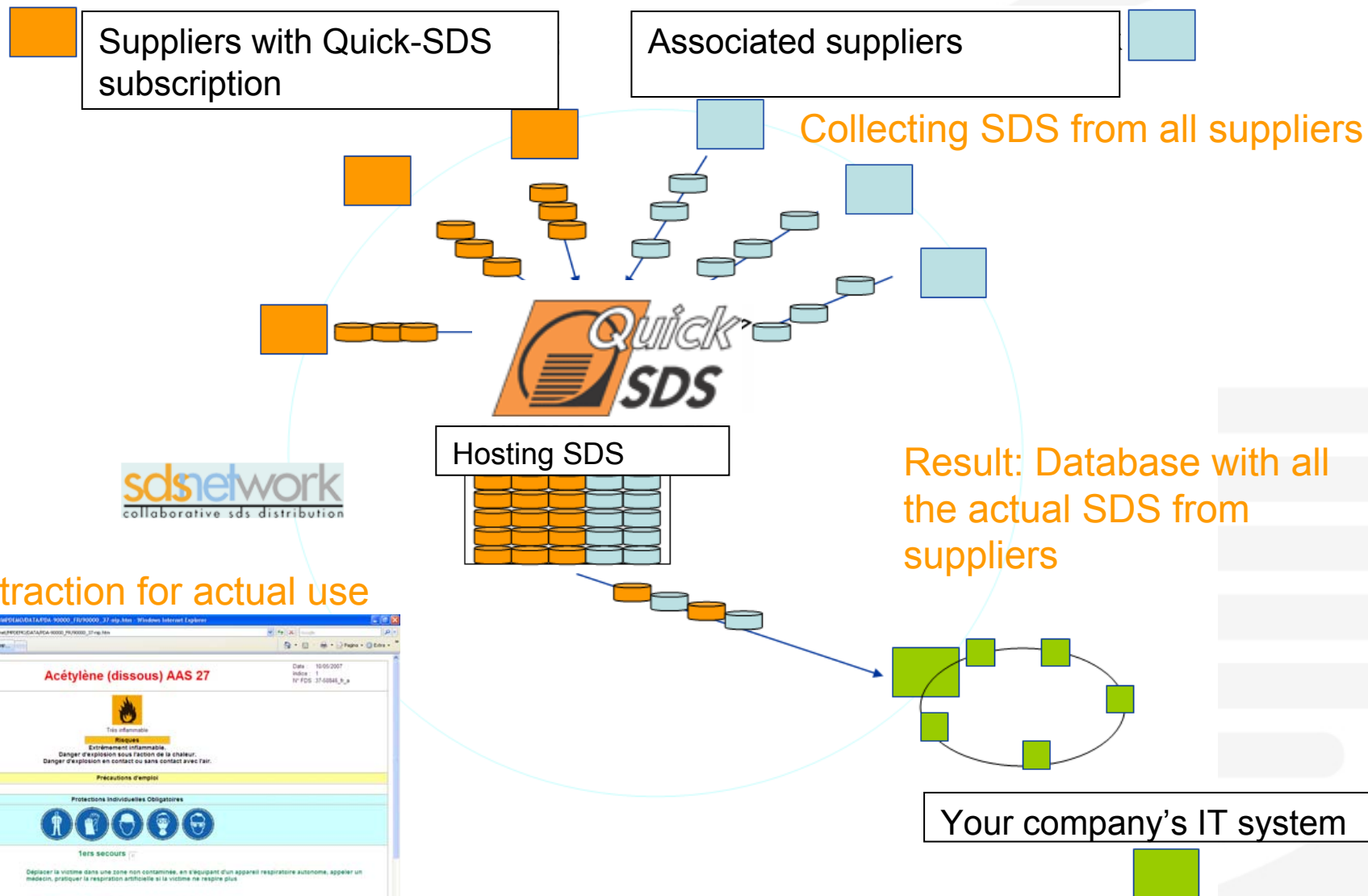



NEW: Communication on usage of a substance

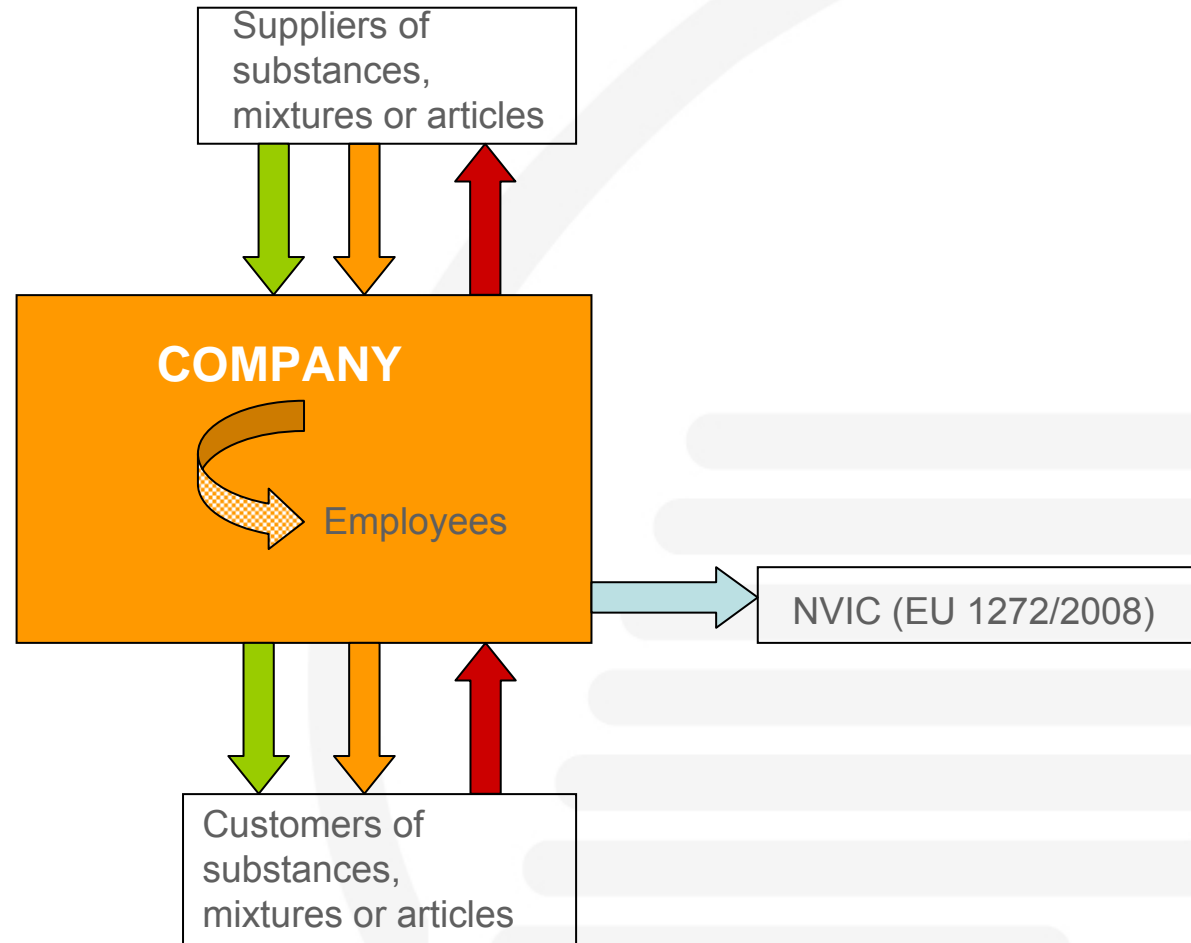

→ REACH new Communication

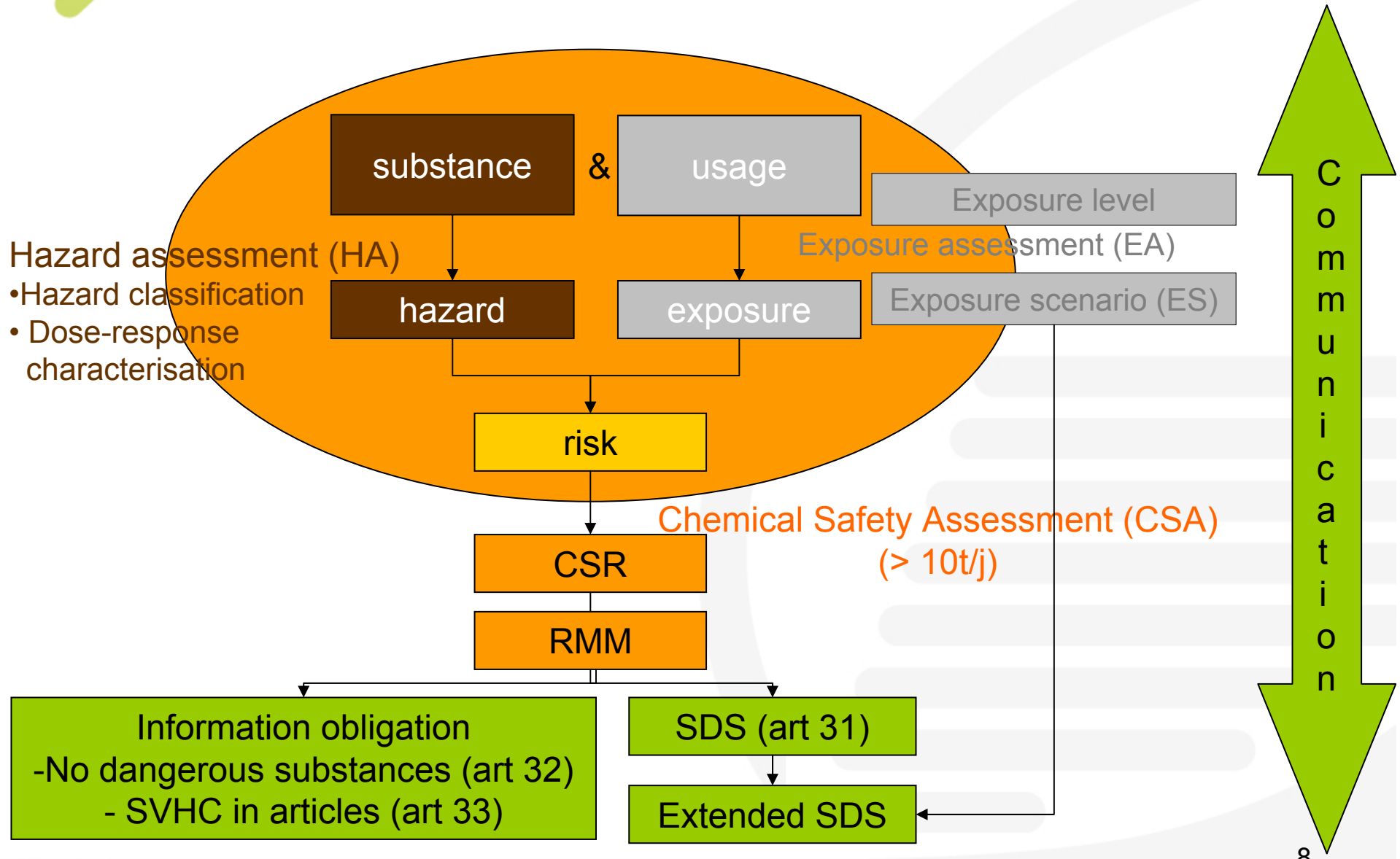



Information in supply chain from downstream users

(*) Apply information in use within 12 months after registration

(**) Apply information in use within 6 months after registration

Role	Item	Distribution	Information	Remarks
User	Substance or preparation	Obligatory: provide information to employee	SDS standard from supplier or subtracted information and self created exposure scenario's(*)	Annex with CSR
User	Substance or preparation	In case of necessity to employee	SDS standard from supplier or subtracted information and self created exposure scenario's(*)	Annex with CSR
User(*)	Any product with SDS obligation	Obligatory , to supplier (producer or distributor)	1) New information on hazardous property 2) information on safety measures from SDS 3) New use one month before applying (*)	
User(*)	Any information for registration	Potential help on registration to supplier	1) Uses 2) Safety measures	12 months
User (**)	Substances with registration obligation on use	Obligatory to ECHA	CSR including exposure scenario's	6 months

→ Registration of substances: obligation to work together





Registration of substances: beyond expectations

More than 150.000 different substances (screening on synonyms, articles, mixtures)
More than 2,6 million preregistrations and more than 71.000 companies, which subscribed

Pre-registration experiences



- pre-SIEF size

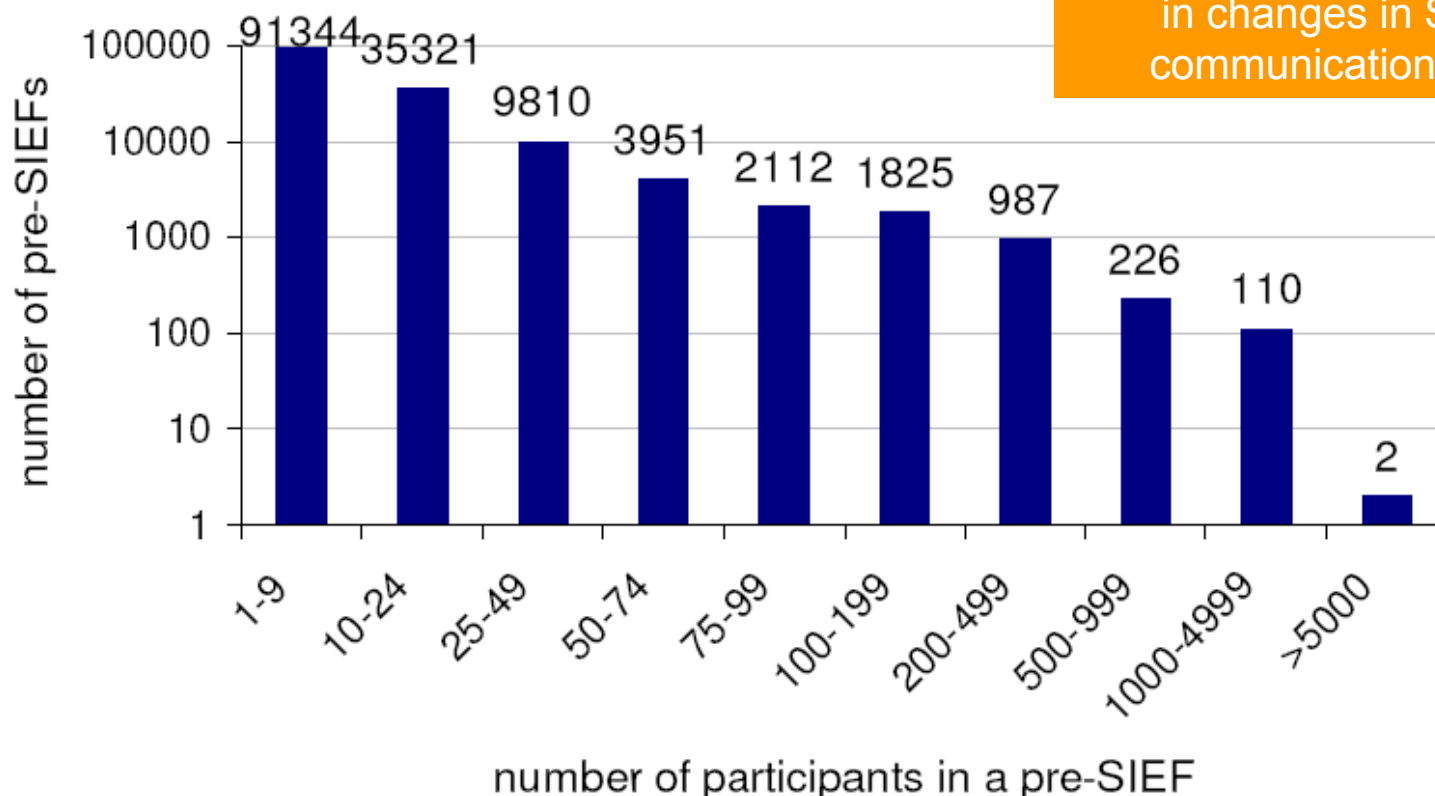

Registration of substances will effect in changes in SDS: additional communication in supply chain



Communication due to EU implementation GHS: CLP

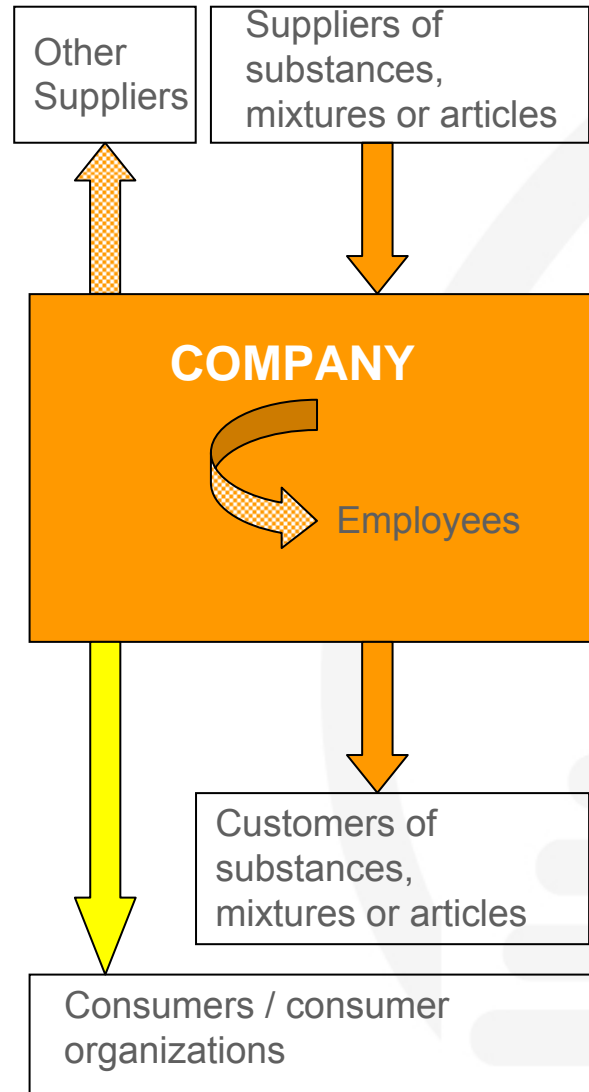



CLP (EU-GHS) timing and rules



▶ September 2008

- Agreement on proposal

▶ End of 2008

- Regulation accepted by EU Parliament and Council of Europe

▶ Start January 20th 2009

- Regulation is valid
- Start change over period for substances and preparations (article 58)
- Labeling en packaging of substances and preparations according [Wms](#) obligatory
- classification, labeling en packaging of substances and preparations according EU-GHS admitted

▶ December 1st 2010

- classification, labeling en packaging of substances and preparations according EU-GHS obligatory (article 58.3)
- classification, labeling en packaging of substances and preparations according [Wms](#) admitted

▶ June 1st 2015

- classification, labeling en packaging of substances and preparations according EU-GHS obligatory
- Deletion of old regulation

CLP will effect in changes in SDS:
additional communication in supply chain

➔ Example: oral acute toxicities

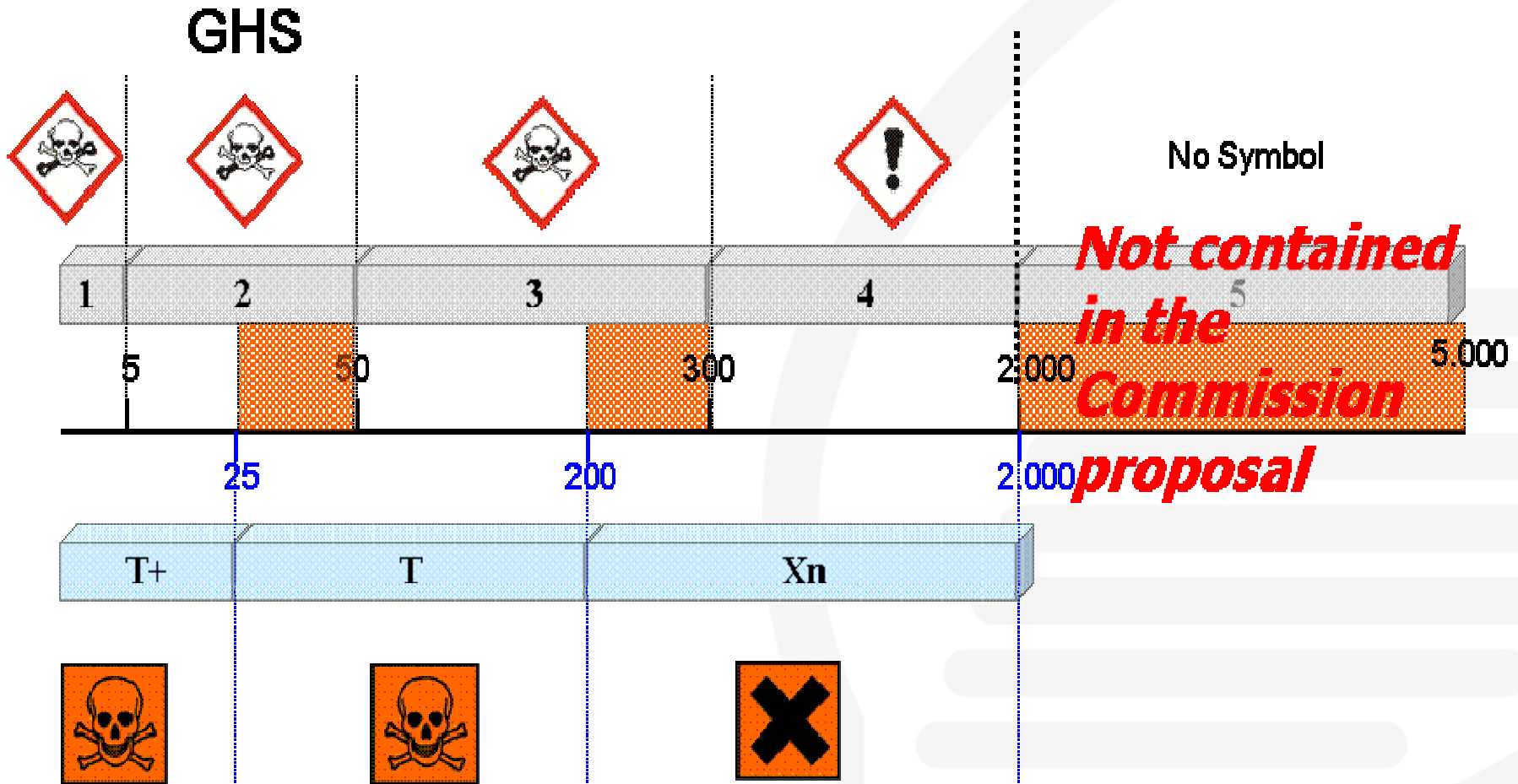



GHS in the world

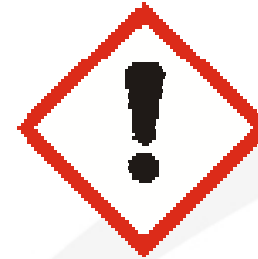
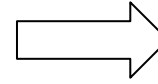

activities

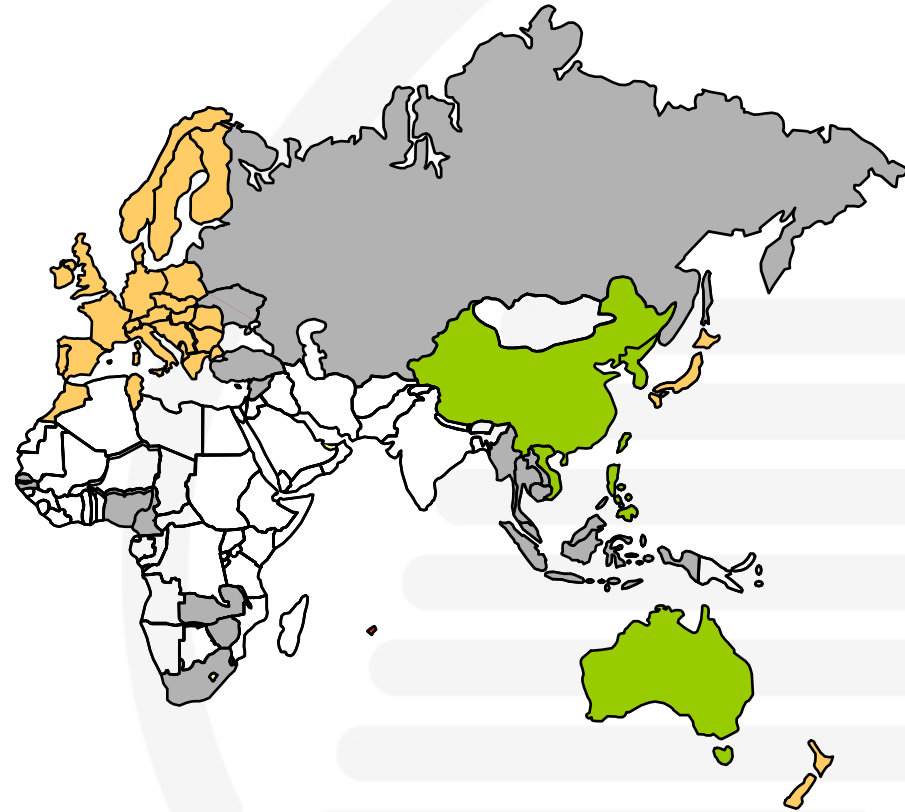

preparation

Implementation

➔ Reporting on SVHC and components

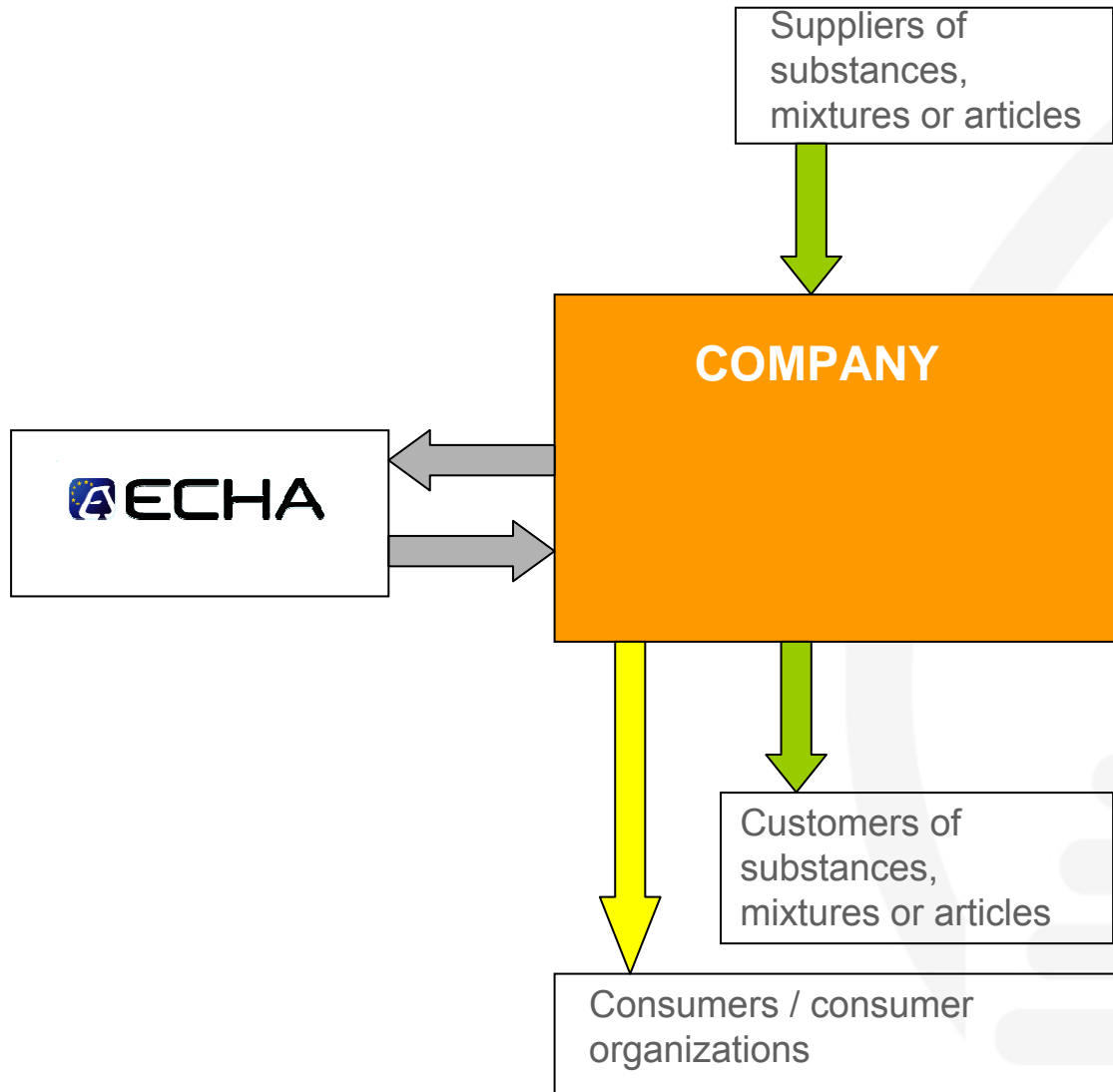

➔ Procedure identification SVHC

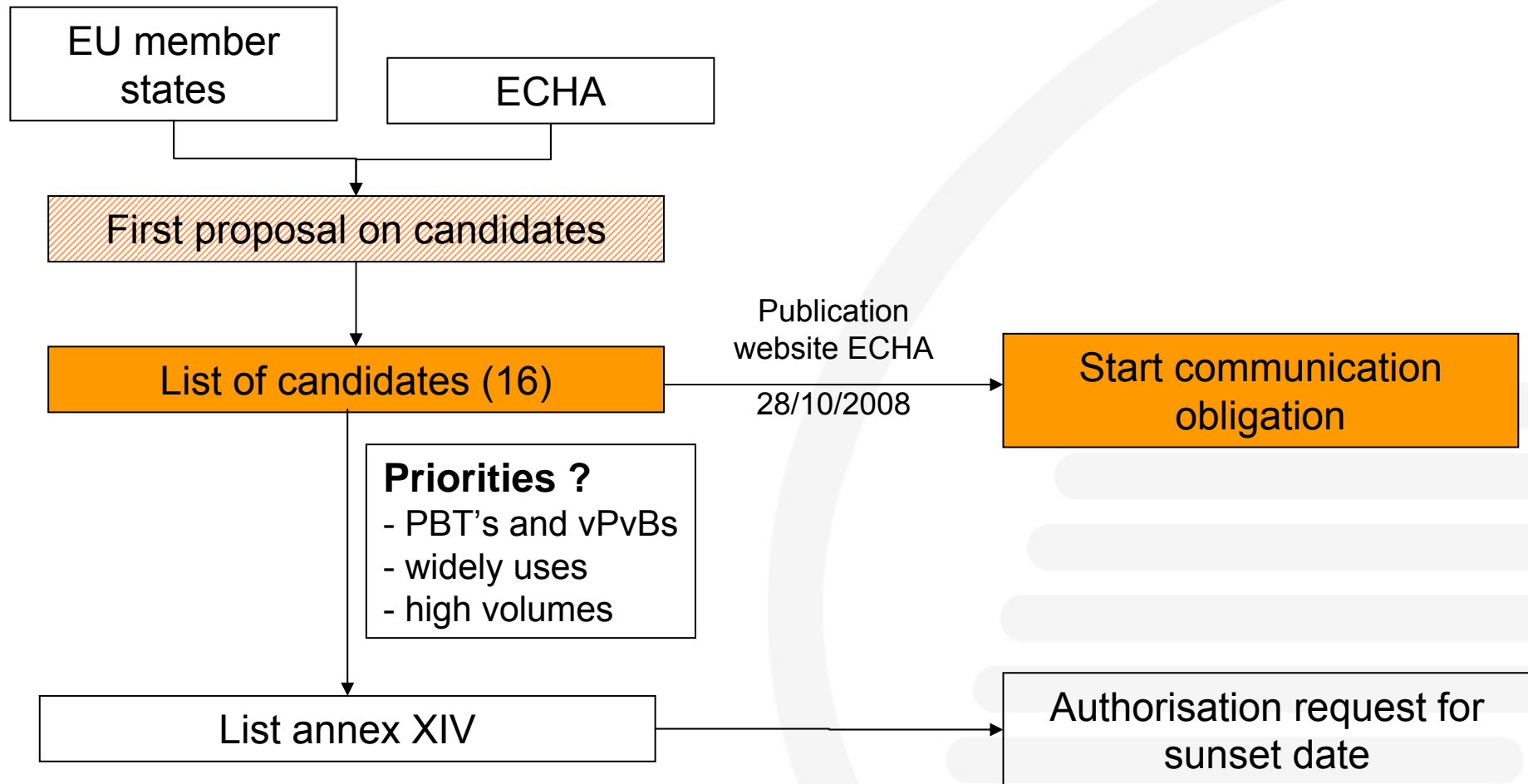

Procedure is on going process: new candidates are in progress (around 200 substances qualify according rumors)



Reporting on SVHC: kind of substance and EU

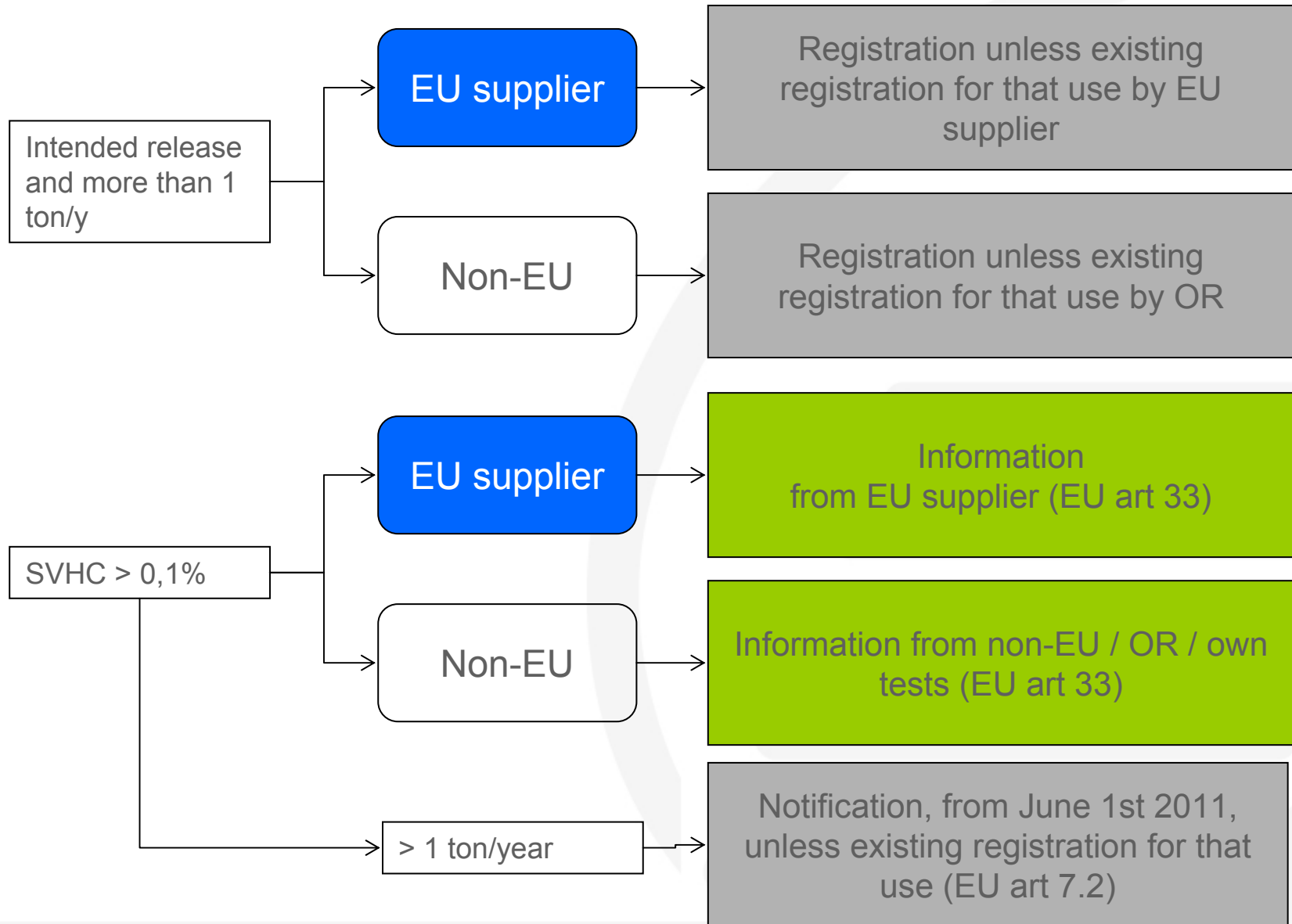

→ Reporting on SVHC and components

<i>Role</i>	<i>Item</i>	<i>Distribution</i>	<i>Information</i>	<i>Remarks</i>
Producer / Importer	Substances SVHC in Articles (Professional) with more than 0.1% weight	Obligatory	1) Name 2) Safe use	45 days
Producer / Importer	Consumer product including substance or preparation	On demand to distributor or customer	1) Name 2) Safe use	45 days
Producer / Importer	Any substance or preparation	Obligatory , to supplier (producer or distributor)	1) New information on hazardous property 2) information on safety measures from SDS	
User	Consumer product including dangerous substance or preparation	On demand to distributor, customer or consumer	1) Name 2) Safe use	45 days

Some companies have other regulation as well: detergents, reporting to consumers on ingredients

➔ Communication to NVIC and audits / inspections





Reporting for medical usage: NVIC

NVIC

- ▶ EU regulation 1272/2008 is defining national institute for information on dangerous substances for professional medical use
- ▶ Focus on prevention and cure
- ▶ In the Netherlands NVIC ('Nationaal Vergiftigingen Informatie Centrum') is responsible for collecting data
- ▶ Companies have to report to NVIC
 - SDS
 - Additional information such as specification of ingredients / components

INSPECTIONS

- ▶ In the Netherlands different inspections are working together: VROM inspection, Labour inspection ('Arbeids inspectie') and Food / goods inspection ('Voedsel en Waren autoriteit') organize joint inspections

<http://www.rivm.nl/milieuportaal/images/Informatieblad%20Product%20Notificatie.pdf>



Communication in and between companies in REACH

